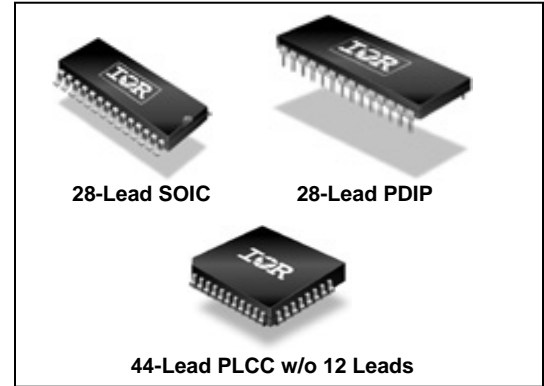


## 3-PHASE BRIDGE DRIVER

### Features

- Floating channel designed for bootstrap operation
- Fully operational to +600 V
- Tolerant to negative transient voltage, dV/dt immune
- Gate drive supply range from 10 V to 20 V (IR2136/IR21368), 11.5 V to 20 V (IR21362D), or 12 V to 20 V (IR21363/IR21365/IR21366/IR21367)
- Undervoltage lockout for all channels
- Over-current shutdown turns off all six drivers
- Independent 3 half-bridge drivers
- Matched propagation delay for all channels
- Cross-conduction prevention logic
- Low side output out of phase with inputs. High side outputs out of phase (IR213(6,63, 65, 66, 67, 68)), or in phase (IR21362) with inputs
- 3.3 V logic compatible
- Lower di/dt gate drive for better noise immunity
- Externally programmable delay for automatic fault clear
- All parts are LEAD-FREE

### Packages



### Description

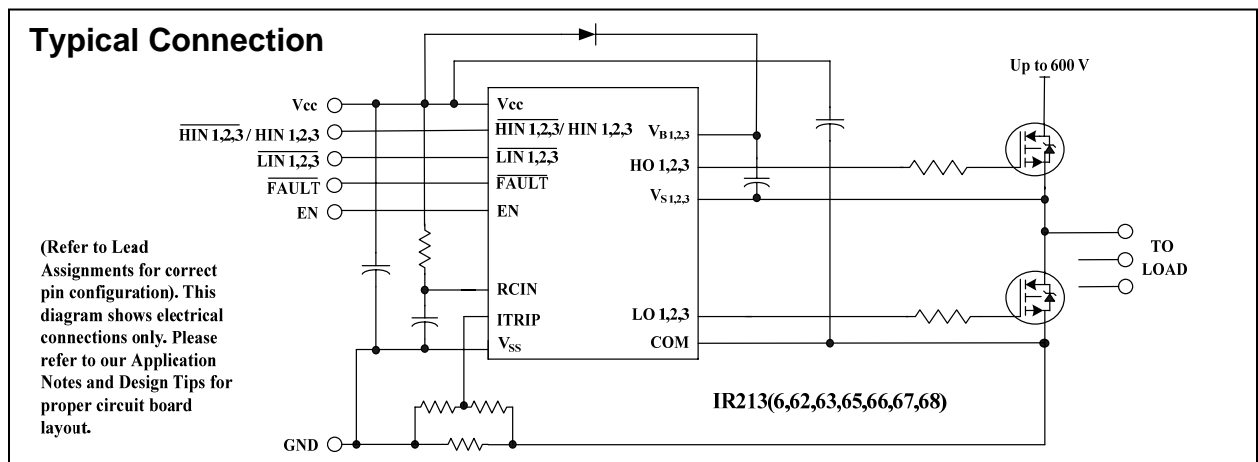
The IR2136x (J&S) are high voltage, high speed power MOSFET and IGBT drivers with three independent high and low side referenced output channels for 3-phase applications. Proprietary HVIC technology enables ruggedized monolithic construction. Logic inputs are compatible with CMOS or LSTTL outputs, down to 3.3 V logic. A current trip function which terminates all six outputs

### Feature Comparison: IR213(6,62,63,65,66,67,68)

Part	IR2136	IR21362	IR21363	IR21365	IR21366	IR21367	IR21368
Input Logic	$\overline{\text{HIN}}, \overline{\text{LIN}}$	$\text{HIN}, \overline{\text{LIN}}$	$\overline{\text{HIN}}, \overline{\text{LIN}}$	$\overline{\text{HIN}}, \overline{\text{LIN}}$	$\overline{\text{HIN}}, \overline{\text{LIN}}$	$\overline{\text{HIN}}, \overline{\text{LIN}}$	$\overline{\text{HIN}}, \overline{\text{LIN}}$
Ton (typ.)	400 ns	400 ns	400 ns	400 ns	250 ns	250 ns	400 ns
Toff (typ.)	380ns	380 ns	380 ns	380 ns	180 ns	180 ns	380 ns
V <sub>in</sub> (typ.)	2.7 V	2.7 V	2.7 V	2.7 V	2.0 V	2.0 V	2.0 V
V <sub>ic</sub> (typ.)	1.7 V	1.7 V	1.7 V	1.7 V	1.3 V	1.3 V	1.3 V
V <sub>trip+</sub>	0.46 V	0.46 V	0.46 V	4.3 V	0.46 V	4.3 V	4.3 V
UVCC/BS+	8.9 V	10.4 V	11.2 V	11.2 V	11.2 V	11.2 V	8.9 V
UVCC/BS-	8.2 V	9.4 V	11.0 V	11.0 V	11.0 V	11.0 V	8.2 V

can be derived from an external current sense resistor. An enable function is available to terminate all six outputs simultaneously. An open-drain FAULT signal is provided to indicate that an overcurrent or undervoltage shutdown has occurred. Overcurrent fault conditions are cleared automatically after a delay programmed externally via an RC network connected to the RCIN input. The output drivers feature a high pulse current buffer stage designed for minimum driver cross-conduction. Propagation delays are matched to simplify use in high frequency applications. The floating channels can be used to drive N-channel power MOSFETs or IGBTs in the high side configuration which operates up to 600 V.

### Typical Connection



### Absolute Maximum Ratings

Absolute Maximum Ratings indicate sustained limits beyond which damage to the device may occur. All voltage parameters are absolute voltages referenced to COM. The thermal resistance and power dissipation ratings are measured under board mounted and still air conditions.

Symbol	Definition	Min	Max	Units	
$V_S$	High side offset voltage	$V_{B1,2,3} - 25$	$V_{B1,2,3} + 0.3$	V	
$V_B$	High side floating supply voltage	-0.3	625		
$V_{HO}$	High side floating output voltage	$V_{S1,2,3} - 0.3$	$V_{B1,2,3} + 0.3$		
$V_{CC}$	Low side and logic fixed supply voltage	-0.3	25		
$V_{SS}$	Logic ground	$V_{CC} - 25$	$V_{CC} + 0.3$		
$V_{LO1,2,3}$	Low side output voltage	-0.3	$V_{CC} + 0.3$		
$V_{IN}$	Input voltage LIN, HIN, ITRIP, EN	$V_{SS} - 0.3$	Lower of ( $V_{SS} + 15$ ) or ( $V_{CC} + 0.3$ )		
$V_{RCIN}$	RCIN input voltage	$V_{SS} - 0.3$	$V_{CC} + 0.3$		
$V_{FLT}$	FAULT output voltage	$V_{SS} - 0.3$	$V_{CC} + 0.3$		
dV/dt	Allowable offset voltage slew rate	—	50		V/ns
$P_D$	Package power dissipation @ $T_A \leq +25^\circ\text{C}$	(28 lead PDIP)	—	1.5	W
		(28 lead SOIC)	—	1.6	
		(44 lead PLCC)	—	2.0	
$R_{thJA}$	Thermal resistance, junction to ambient	(28 lead PDIP)	—	83	$^\circ\text{C}/\text{W}$
		(28 lead SOIC)	—	78	
		(44 lead PLCC)	—	63	
$T_J$	Junction temperature	—	150	$^\circ\text{C}$	
$T_S$	Storage temperature	-55	150		
$T_L$	Lead temperature (soldering, 10 seconds)	—	300		

### Recommended Operating Conditions

The input/output logic-timing diagram is shown in Fig. 1. For proper operation the device should be used within the recommended conditions. All voltage parameters are absolute referenced to COM. The  $V_S$  offset ratings are tested with all supplies biased at a 15 V differential.

Symbol	Definition	Min	Max	Units	
$V_{B1,2,3}$	High side floating supply voltage	IR213(6,68)	$V_{S1,2,3} + 10$	$V_{S1,2,3} + 20$	V
		IR21362	$V_{S1,2,3} + 11.5$	$V_{S1,2,3} + 20$	
		IR213(6,63,65,66,67)	$V_{S1,2,3} + 12$	$V_{S1,2,3} + 20$	
$V_{S1,2,3}$	High side floating supply offset voltage	Note 1	600		
$V_{HO1,2,3}$	High side output voltage	$V_{S1,2,3}$	$V_{B1,2,3}$		
$V_{LO1,2,3}$	Low side output voltage	0	$V_{CC}$		
$V_{CC}$	Low side and logic fixed supply voltage	IR213(6,68)	10	20	
		IR21362	11.5	20	
		IR213(6,63,65,66,67)	12	20	
$V_{SS}$	Logic ground	-5	5		
$V_{FLT}$	FAULT output voltage	$V_{SS}$	$V_{CC}$		
$V_{RCIN}$	RCIN input voltage	$V_{SS}$	$V_{CC}$		

**Note 1:** Logic operational for  $V_S$  of (COM - 5 V) to (COM + 600 V). Logic state held for  $V_S$  of (COM - 5 V) to (COM -  $V_{BS}$ ). (Please refer to the Design Tip DT97-3 for more details).

**Note 2:** All input pins and the ITRIP and EN pins are internally clamped with a 5.2 V zener diode.

### Recommended Operating Conditions - (Continued)

The input/output logic-timing diagram is shown in Fig. 1. For proper operation the device should be used within the recommended conditions. All voltage parameters are absolute referenced to COM. The  $V_S$  offset ratings are tested with all supplies biased at a 15 V differential.

Symbol	Definition	Min	Max	Units
$V_{ITRIP}$	ITRIP input voltage	$V_{SS}$	$V_{SS} + 5$	V
$V_{IN}$	Logic input voltage $\overline{LIN}$ , $\overline{HIN}$ (IR213(6,63,65,66,67,68)), $HIN$ (IR21362), EN	$V_{SS}$	$V_{SS} + 5$	
$T_A$	Ambient temperature	-40	125	°C

**Note 2:** All input pins and the ITRIP and EN pins are internally clamped with a 5.2 V zener diode.

### Static Electrical Characteristics

$V_{BIAS}$  ( $V_{CC}, V_{BS1,2,3}$ ) = 15 V unless otherwise specified. The  $V_{IN}$ ,  $V_{TH}$ , and  $I_{IN}$  parameters are referenced to  $V_{SS}$  and are applicable to all six channels ( $\overline{HIN1,2,3}$  and  $\overline{LIN1,2,3}$ ). The  $V_O$  and  $I_O$  parameters are referenced to COM and  $V_{S1,2,3}$  and are applicable to the respective output leads: HO1,2,3 and LO1,2,3.

Symbol	Definition	Min	Typ	Max	Units	Test Conditions	
$V_{IH}$	Logic "0" input voltage $\overline{LIN1,2,3}$ , $\overline{HIN1,2,3}$ IR213(6,63,65)	3.0	—	—	V		
	Logic "1" input voltage $HIN1,2,3$ IR21362						
$V_{IL}$	Logic "0" input voltage $\overline{LIN1,2,3}$ , $\overline{HIN1,2,3}$ IR213(66,67,68)	2.5	—	—			
	Logic "1" input Voltage $\overline{LIN1,2,3}$ , $\overline{HIN1,2,3}$ IR213(6,63,65)	—	—	0.8			
$V_{IL}$	Logic "0" input voltage $HIN1,2,3$ IR21362						
	Logic "0" input voltage $\overline{LIN1,2,3}$ , $\overline{HIN1,2,3}$ IR213(66,67,68)						
$V_{EN,TH+}$	Enable positive going threshold	—	—	3			
$V_{EN,TH-}$	Enable negative going threshold	0.8	—	—			
$V_{IT,TH+}$	ITRIP positive going threshold	IR2136(2)(3)(6)	0.37	0.46			0.55
		IR21365(7)(8)	3.85	4.30			4.75
$V_{IT,HYS}$	ITRIP input hysteresis	IR2136(2)(3)(6)	—	0.07	—		
		IR21365(7)(8)	—	.15	—		
$V_{RCIN, TH+}$	RCIN positive going threshold	—	8	—			
$V_{RCIN, HYS}$	RCIN input hysteresis	—	3	—			
$V_{OH}$	High level output voltage, $V_{BIAS} - V_O$	—	0.9	1.4		$I_O = 20$ mA	
$V_{OL}$	Low level output voltage, $V_O$	—	0.4	0.6			
$V_{CCUV+}$ $V_{BSUV+}$	$V_{CC}$ and $V_{BS}$ supply undervoltage positive going threshold	IR2136(8)	8.0	8.9	9.8		
		IR21362	9.6	10.4	11.2		
		IR21363(5)(6)(7)	10.6	11.1	11.6		

**Static Electrical Characteristics - (Continued)**

V<sub>BIAS</sub> (V<sub>CC</sub>, V<sub>BS1,2,3</sub>) = 15 V unless otherwise specified. The V<sub>IN</sub>, V<sub>TH</sub>, and I<sub>IN</sub> parameters are referenced to V<sub>SS</sub> and are applicable to all six channels (HIN1,2,3 and LIN1,2,3). The V<sub>O</sub> and I<sub>O</sub> parameters are referenced to COM and V<sub>S1,2,3</sub> and are applicable to the respective output leads: HO1,2,3 and LO1,2,3.

Symbol	Definition	Min	Typ	Max	Units	Test Conditions	
V <sub>CCUV-</sub> V <sub>BSUV-</sub>	V <sub>CC</sub> and V <sub>BS</sub> supply undervoltage negative going threshold	IR2136(8)	7.4	8.2	9.0	V	
		IR21362	8.6	9.4	10.2		
		IR2136(3,5,6,7)	10.4	10.9	11.4		
V <sub>CCUVH</sub> V <sub>BSUVH</sub>	V <sub>CC</sub> and V <sub>BS</sub> supply undervoltage lockout hysteresis	IR2136	0.3	0.7	—		
		IR21362	0.5	1.0	—		
		IR2136(3,5)	—	0.2	—		
I <sub>LK</sub>	Offset supply leakage current	—	—	50	μA	V <sub>B1,2,3</sub> = V <sub>S1,2,3</sub> = 600 V	
I <sub>QBS</sub>	Quiescent V <sub>BS</sub> supply current	—	70	120	mA	V <sub>IN</sub> = 0 V or 5 V	
I <sub>QCC</sub>	Quiescent V <sub>CC</sub> supply current	—	1.6	2.3			
V <sub>IN,CLAMP</sub>	Input clamp voltage (HIN, LIN, ITRIP and EN)	4.9	5.2	5.5	V	I <sub>IN</sub> = 100 μA	
I <sub>LIN+</sub>	Input bias current (LOUT = HI)	IR2136(2,3,5)	—	200	300	μA	V <sub>LIN</sub> = 5 V
		IR2136(6,7,8)	—	30	100		V <sub>LIN</sub> = 0 V
I <sub>LIN-</sub>	Input bias current (LOUT = LO)	IR2136(2,3,5)	—	100	220		V <sub>HIN</sub> = 5 V
		IR2136(6,7,8)	—	0	1		
I <sub>HIN+</sub>	Input bias current (HOOUT = HI)	IR2136(3,5)	—	200	300		V <sub>HIN</sub> = 0 V
		IR21362	—	30	100		
		IR2136(6,7,8)	—	30	100		
I <sub>HIN-</sub>	Input bias current (HOOUT = LO)	IR2136(3,5)	—	100	220		V <sub>ITRIP</sub> = 5 V
		IR2136(2,6,7,8)	—	0	1		
I <sub>ITRIP+</sub>	“High” ITRIP input bias current	—	30	100			V <sub>ITRIP</sub> = 0 V
I <sub>ITRIP-</sub>	“Low” ITRIP input bias current	—	0	1			V <sub>ENABLE</sub> = 5 V
I <sub>EN+</sub>	“High” ENABLE input bias current	—	30	100			V <sub>ENABLE</sub> = 0 V
I <sub>EN-</sub>	“Low” ENABLE input bias current	—	0	1			V <sub>rcin</sub> = 0 V or 15 V
I <sub>RCIN</sub>	RCIN input bias current	—	0	1			
I <sub>O+</sub>	Output high short circuit pulsed current	120	200	—	mA		V <sub>O</sub> = 0 V, PW ≤ 10 μs
I <sub>O-</sub>	Output low short circuit pulsed current	250	350	—			V <sub>O</sub> = 15 V, PW ≤ 10 μs
R <sub>on_RCIN</sub>	RCIN low on resistance	—	50	100	Ω		
R <sub>on_FAULT</sub>	FAULT low on resistance	—	50	100			

### Dynamic Electrical Characteristics

$V_{CC} = V_{BS} = V_{BIAS} = 15\text{ V}$ ,  $V_{S1,2,3} = V_{SS} = \text{COM}$ ,  $T_A = 25\text{ }^\circ\text{C}$  and  $C_L = 1000\text{ pF}$  unless otherwise specified.

Symbol	Definition	Min	Typ	Max	Units	Test Conditions	
$t_{on}$	Turn-on propagation delay	IR2136(2,3,5,8)	300	425	550	ns	$V_{IN} = 0\text{ V} \& 5\text{ V}$
		IR2136(6,7)	—	250	—		
$t_{off}$	Turn-off propagation delay	IR2136(2,3,5,8)	250	400	550		
		IR2136(6,7)	—	180	—		
$t_r$	Turn-on rise time	—	125	190			
$t_f$	Turn-off fall time	—	50	75			
$t_{EN}$	ENABLE low to output shutdown propagation delay	IR2136(2,3,5,8)	300	450	600		$V_{IN}, V_{EN} = 0\text{ V}$ or $5\text{ V}$
		IR2136(6,7)	100	250	400		
$t_{ITRIP}$	ITRIP to output shutdown propagation delay	500	750	1000	$V_{ITRIP} = 5\text{ V}$		
$t_{bl}$	ITRIP blanking time	100	150	—	$V_{IN} = 0\text{ V}$ or $5\text{ V}$ $V_{ITRIP} = 5\text{ V}$		
$t_{FLT}$	ITRIP to $\overline{\text{FAULT}}$ propagation delay	400	600	800			
$t_{FILIN}$	Input filter time (HIN, LIN) (IR213(6,62,63,65,68) only)	100	200	—	$V_{IN} = 0\text{ V} \& 5\text{ V}$		
$t_{FLTCLR}$	FAULT clear time RCIN: $R = 2\text{ M}\Omega$ , $C = 1\text{ nF}$	1.3	1.65	2	ms	$V_{IN} = 0\text{ V}$ or $5\text{ V}$ $V_{ITRIP} = 0\text{ V}$	
DT	Deadtime	220	290	360	ns	$V_{IN} = 0\text{ V} \& 5\text{ V}$	
MT	Matching delay ON and OFF	—	40	75			
MDT	Matching delay, $\max(t_{on}, t_{off}) - \min(t_{on}, t_{off})$ , ( $t_{on}, t_{off}$ are applicable to all 3 channels)	—	25	70		External dead time >400 ns	
PM	Output pulse width matching (pwin-pwout) (Fig.2)	—	40	75			

**Note:** For high side PWM, HIN pulse width must be  $\geq 1\text{ }\mu\text{s}$ .

VCC	VBS	ITRIP	ENABLE	FAULT	LO1,2,3	HO1,2,3
<UVCC	X	X	X	0 (note 1)	0	0
15 V	<UVBS	0 V	5 V	high imp	LIN1,2,3	0
15 V	15 V	0 V	5 V	high imp	LIN1,2,3	HIN1,2,3
15 V	15 V	$>V_{ITRIP}$	5 V	0 (note 2)	0	0
15 V	15 V	0 V	0 V	high imp	0	0

**Note 1:** A shoot-through prevention logic prevents LO1,2,3 and HO1,2,3 for each channel from turning on simultaneously.

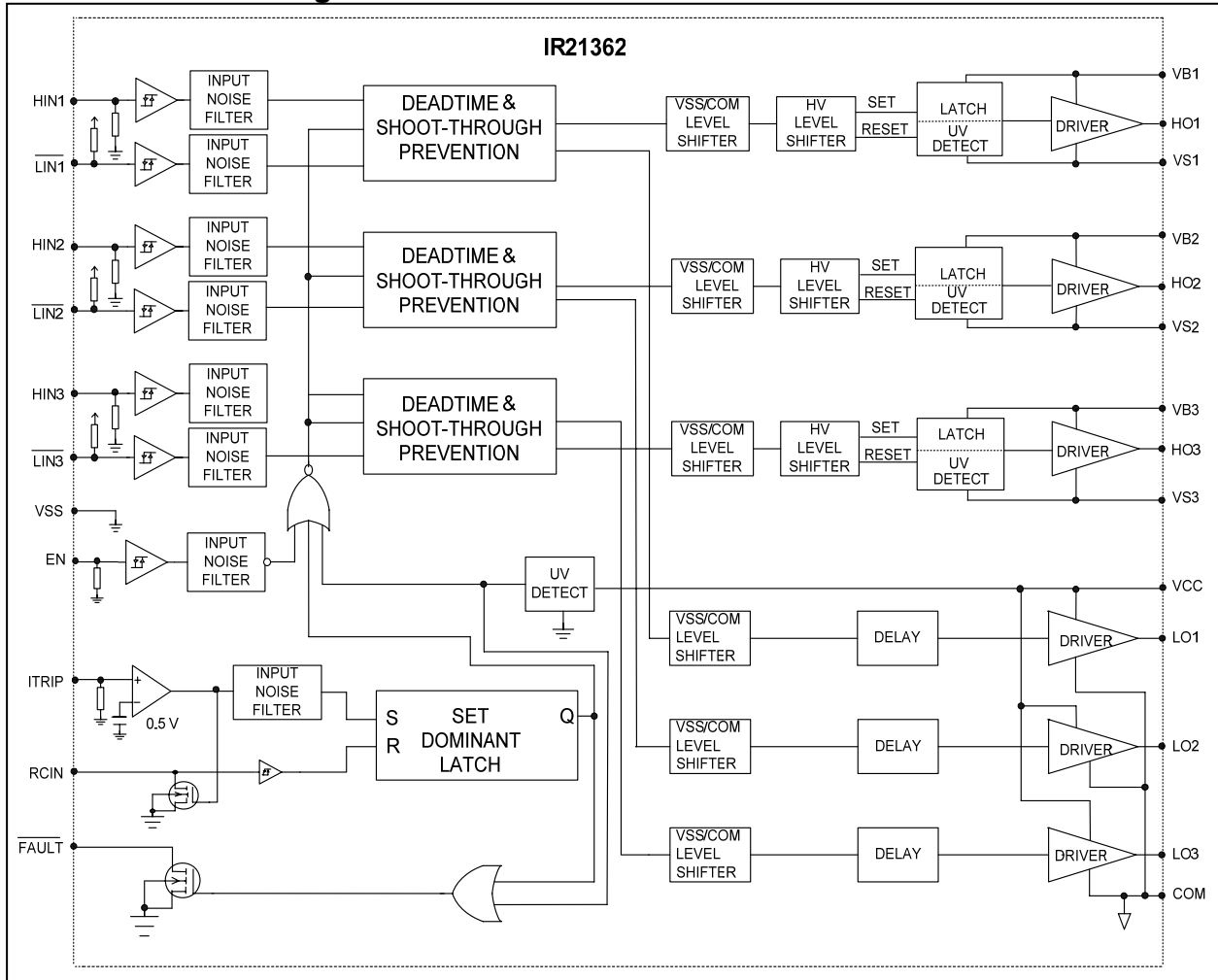
**Note 2:** UVCC is not latched, when  $V_{CC} > UV_{CC}$ , FAULT returns to high impedance.

**Note 3:** When  $ITRIP < V_{ITRIP}$ , FAULT returns to high-impedance after RCIN pin becomes greater than 8 V (@  $V_{CC} = 15\text{ V}$ ).

Functional Block Diagram



**Functional Block Diagram**



**Functional Block Diagram**



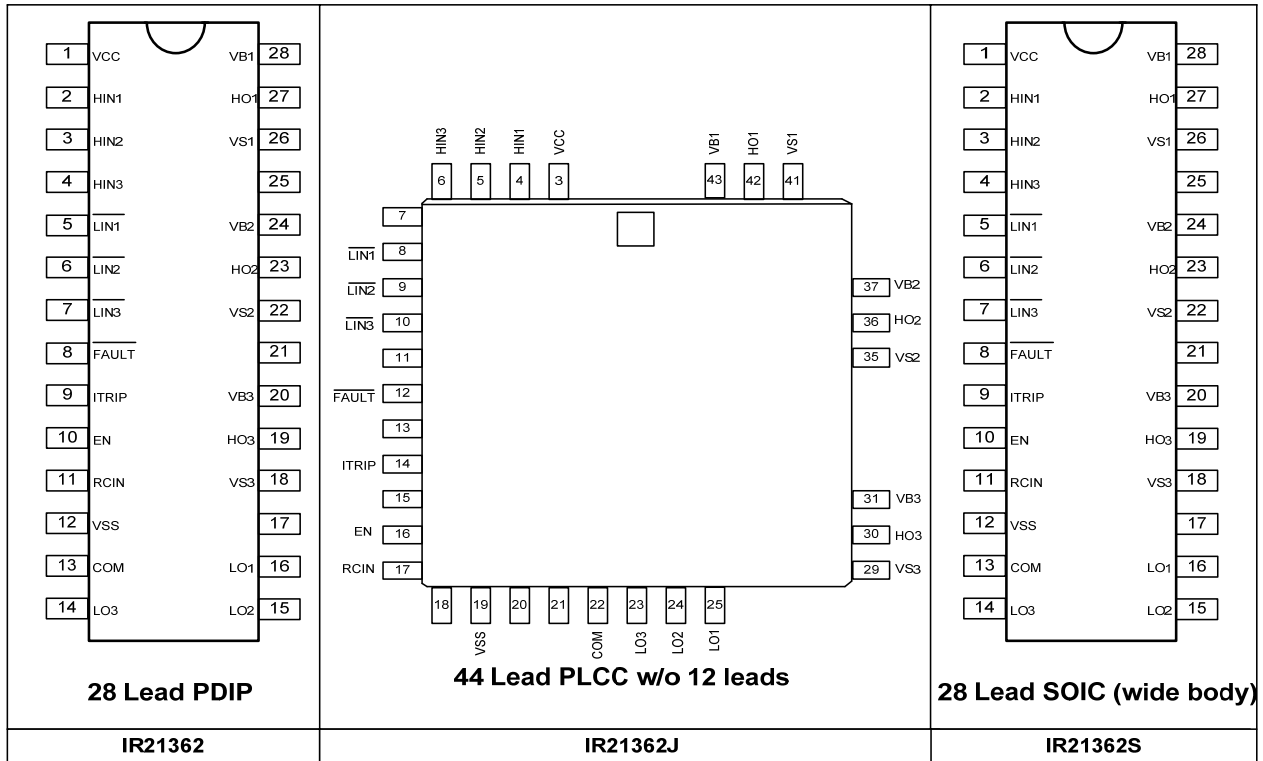
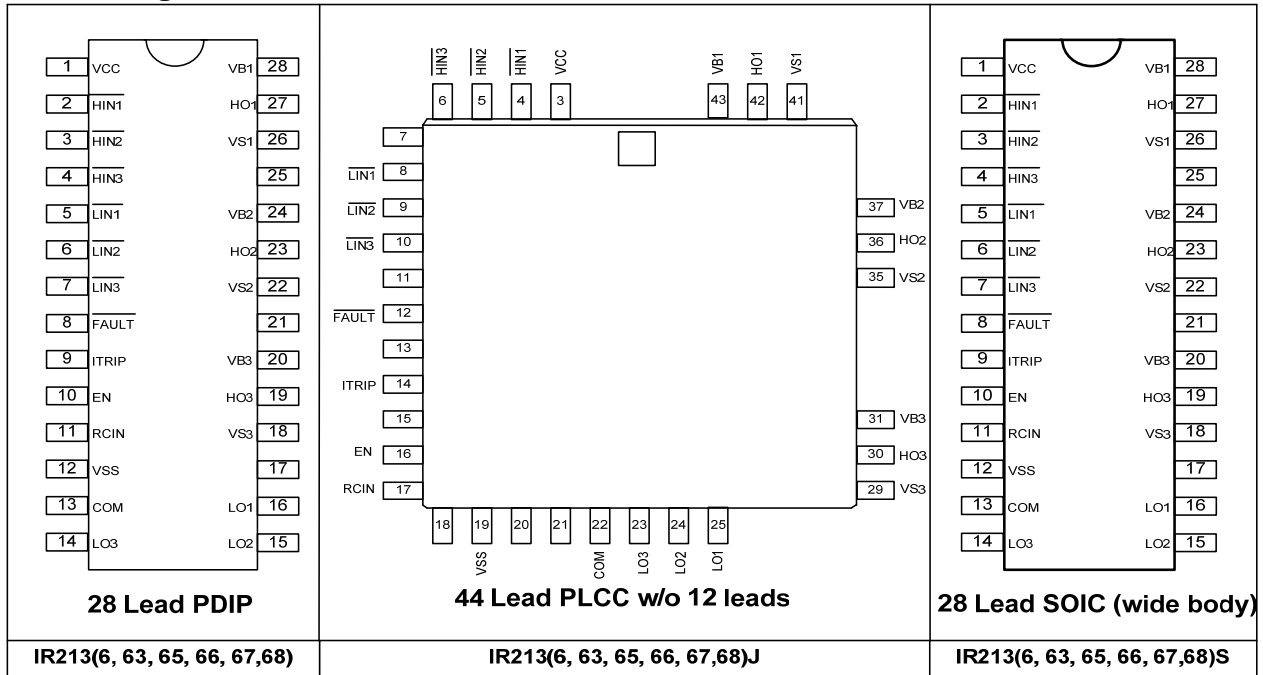


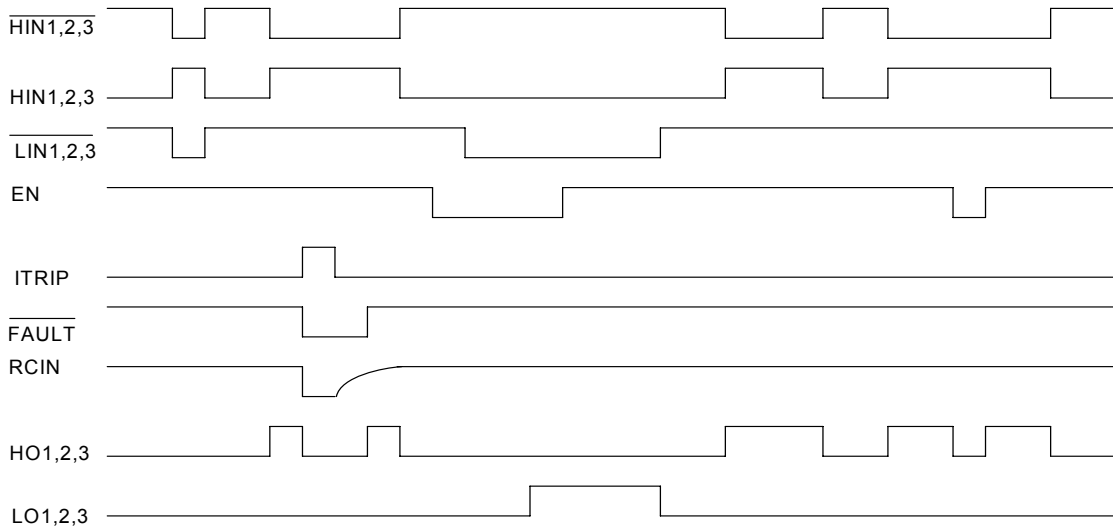
**Lead Definitions**

Symbol	Description
V <sub>CC</sub>	Low side and logic fixed supply
V <sub>SS</sub>	Logic ground
HIN <sub>1,2,3</sub> HIN <sub>1,2,3</sub>	Logic inputs for high side gate driver outputs (HO <sub>1,2,3</sub> ), out of phase [IR213(6,63,65,66,67,68)] Logic inputs for high side gate driver outputs (HO <sub>1,2,3</sub> ), in phase (IR21362)
LIN <sub>1,2,3</sub>	Logic input for low side gate driver outputs (LO <sub>1,2,3</sub> ), out of phase
FAULT	Indicates over-current (ITRIP) or low-side undervoltage lockout has occurred. Negative logic, open-drain output
EN	Logic input to enable I/O functionality. I/O logic functions when ENABLE is high (i.e., positive logic) No effect on FAULT and not latched
ITRIP	Analog input for overcurrent shutdown. When active, ITRIP shuts down outputs and activates FAULT and RCIN low. When ITRIP becomes inactive, FAULT stays active low for an externally set time T <sub>FLTCLR</sub> , then automatically becomes inactive (open-drain high impedance).
RCIN	External RC network input used to define FAULT CLEAR delay, T <sub>FLTCLR</sub> , approximately equal to R*C. When RCIN>8 V, the FAULT pin goes back into open-drain high-impedance
COM	Low side gate drivers return
V <sub>B1,2,3</sub>	High side floating supply
HO <sub>1,2,3</sub>	High side gate driver outputs
V <sub>S1,2,3</sub>	High voltage floating supply return
LO <sub>1,2,3</sub>	Low side gate driver outputs

**Note:** All input pins and the ITRIP pin are internally clamped with a 5.2 V zener diode.

**Lead Assignments**





**Fig. 1. Input/Output Timing Diagram**



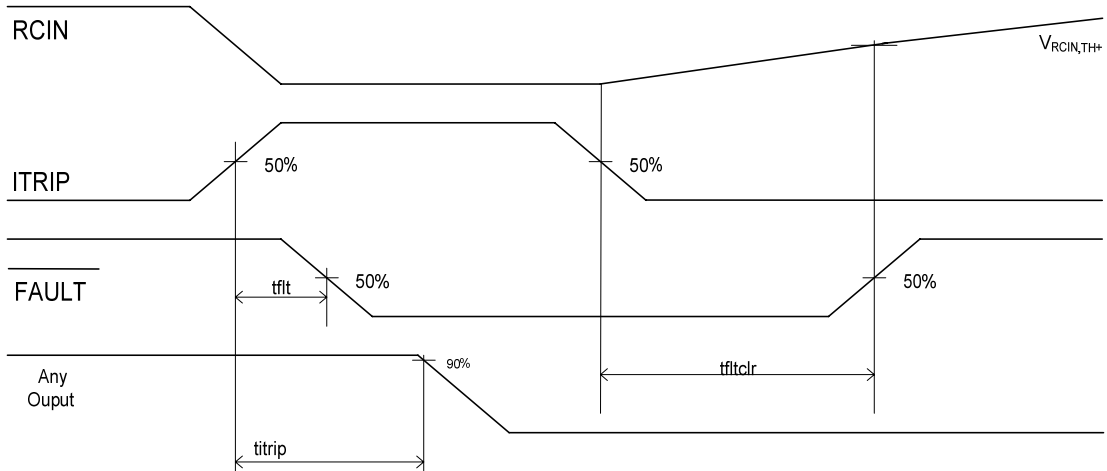
**Fig. 2. Switching Time Waveforms**



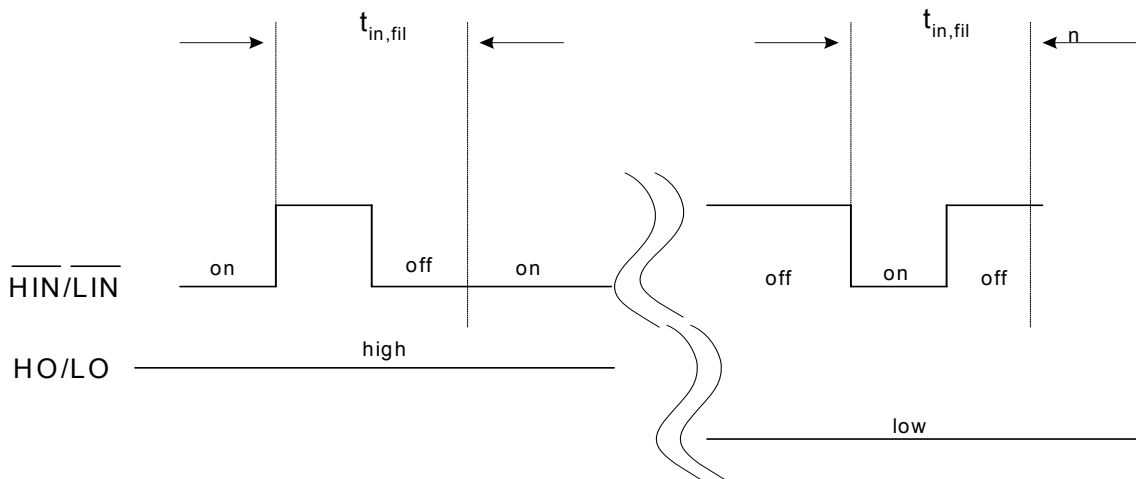
**Fig. 3. Output Enable Timing Waveform**



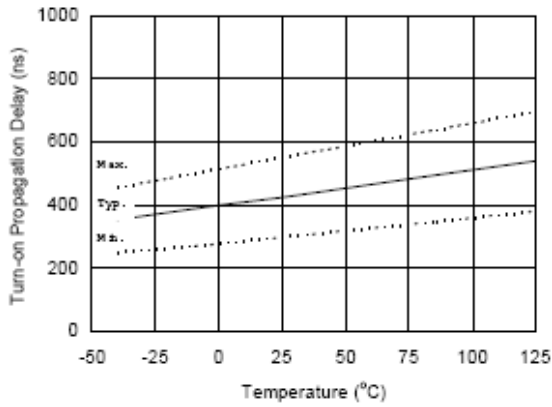
**Fig. 4. Internal Deadtime Timing Waveforms**



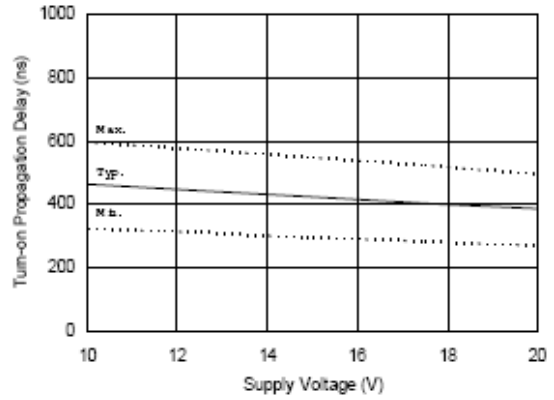
**Fig. 5. ITRIP/RCIN Timing Waveforms**



**Fig. 6. Input Filter Function**



**Figure 6A. Turn-on Propagation Delay vs. Temperature**



**Figure 6B. Turn-on Propagation Delay vs. Supply Voltage**



**Figure 6C. Turn-on Propagation Delay vs. Input Voltage**



**Figure 7A. Turn-off Propagation Delay vs. Temperature**

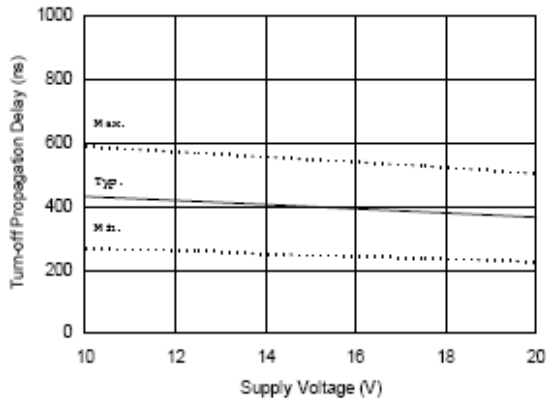


Figure 7B. Turn-off Propagation Delay vs. Supply Voltage

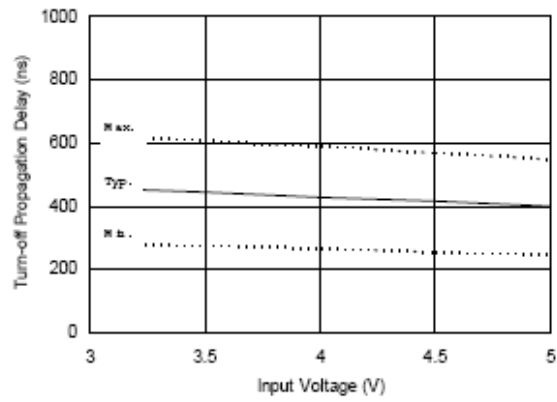


Figure 7C. Turn-off Propagation Delay vs. Input Voltage

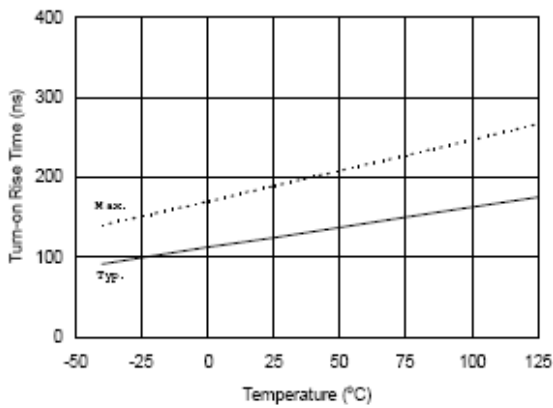


Figure 8A. Turn-on Rise Time vs. Temperature

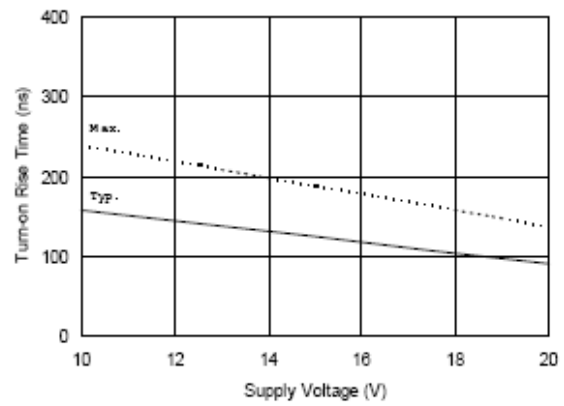


Figure 8B. Turn-on Rise Time vs. Supply Voltage



Figure 9A. Turn-off Fall Time vs. Temperature

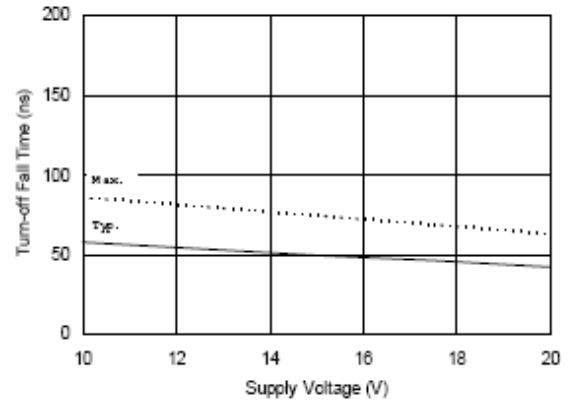


Figure 9B. Turn-off Fall Time vs. Supply Voltage

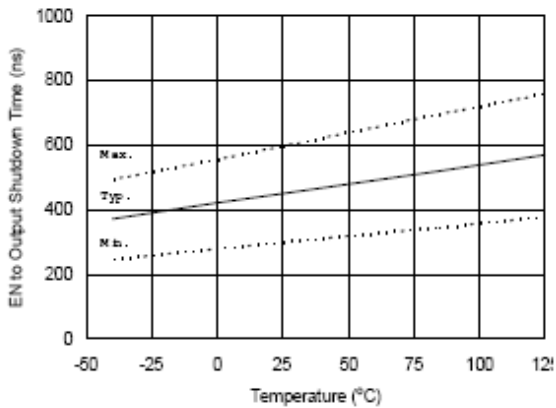


Figure 10A. EN to Output Shutdown Time vs. Temperature

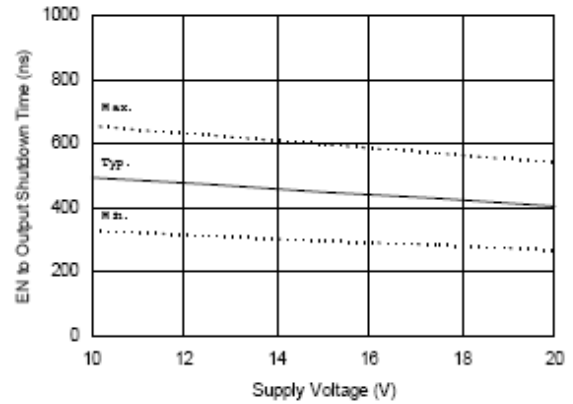


Figure 10B. EN to Output Shutdown Time vs. Supply Voltage

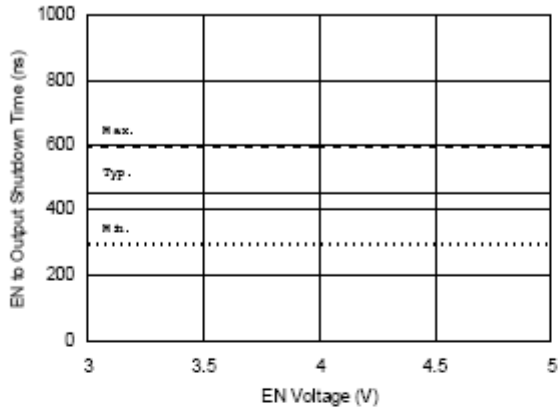


Figure 10C. EN to Output Shutdown Time vs. EN Voltage

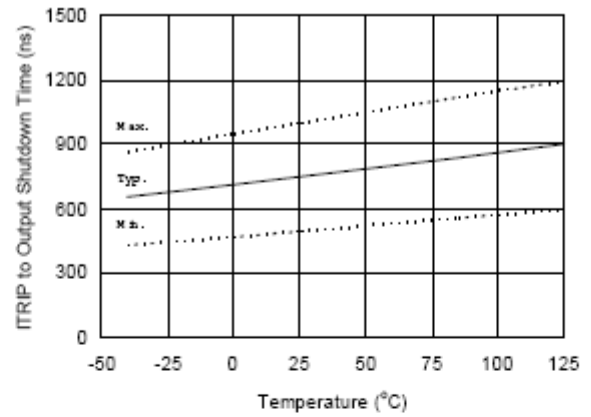


Figure 11A. ITRIP to Output Shutdown Time vs. Temperature

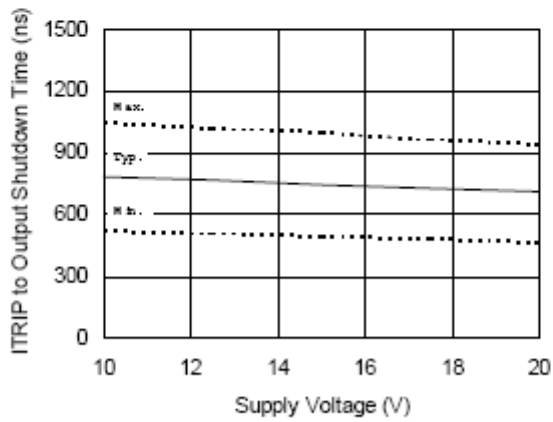


Figure 11B. ITRIP to Output Shutdown Time vs. Supply Voltage

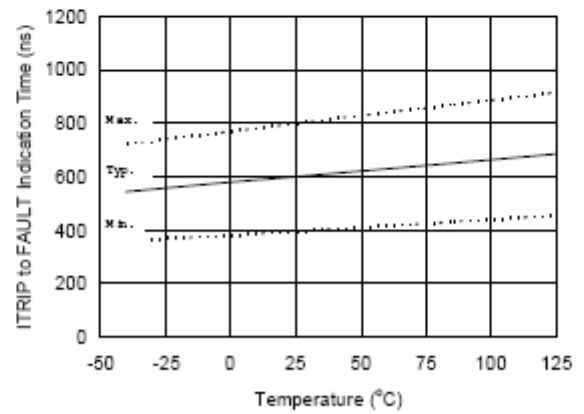
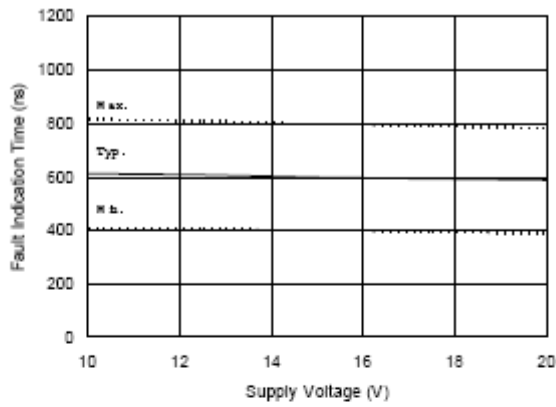
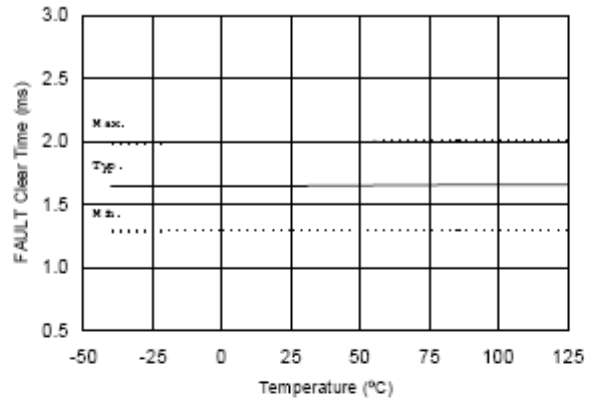


Figure 12A. ITRIP to FAULT Indication Time vs. Temperature

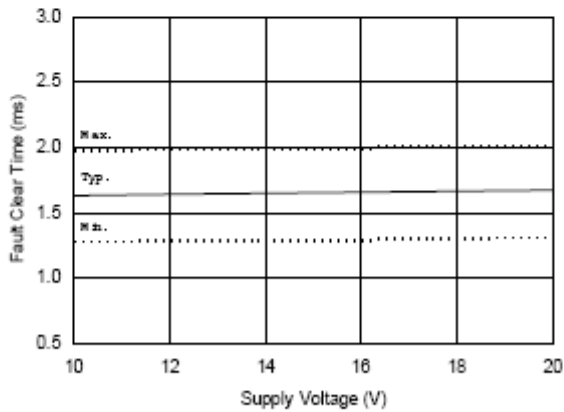




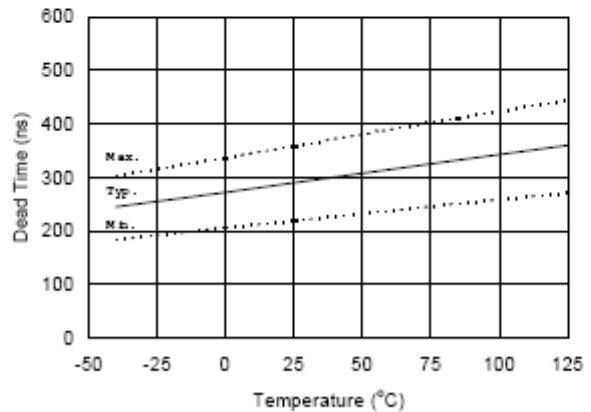
**Figure 12B. ITRIP to FAULT Indication Time vs. Supply Voltage**



**Fig13A. FAULT Clear Time vs. Temperature**



**Figure 13B. FAULT Clear Time vs. Supply Voltage**



**Figure 14A. Dead Time vs. Temperature**

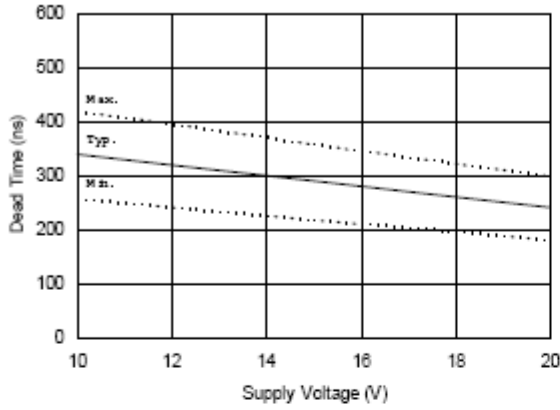


Figure 14B. Dead Time vs. Supply Voltage

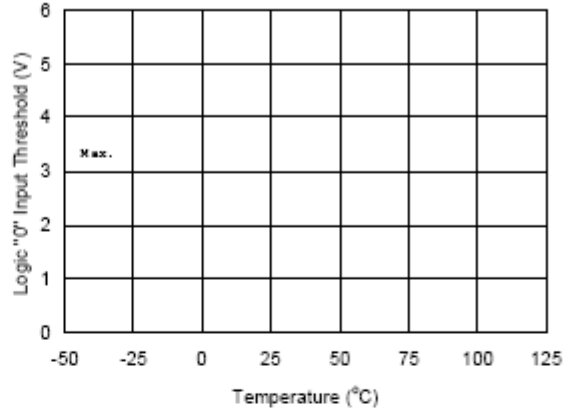


Figure 15A. Logic "0" Input Threshold vs. Temperature

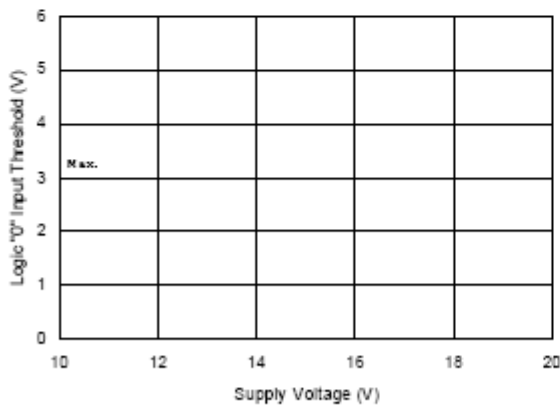


Figure 15B. Logic "0" Input Threshold vs. Supply Voltage

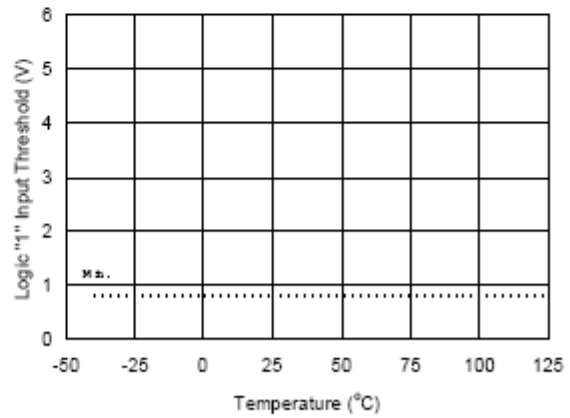
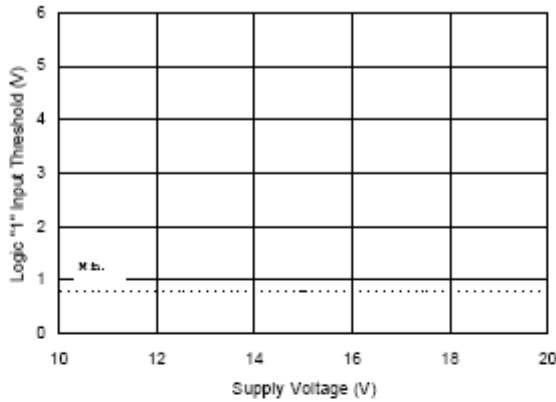
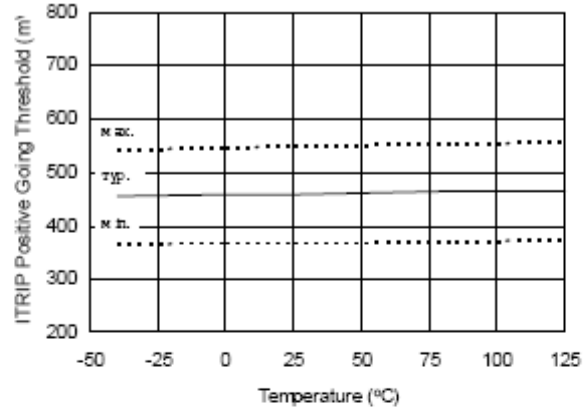


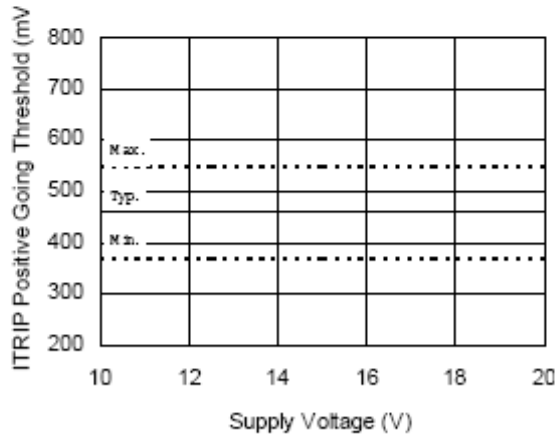
Figure 16A. Logic "1" Input Threshold vs. Temperature



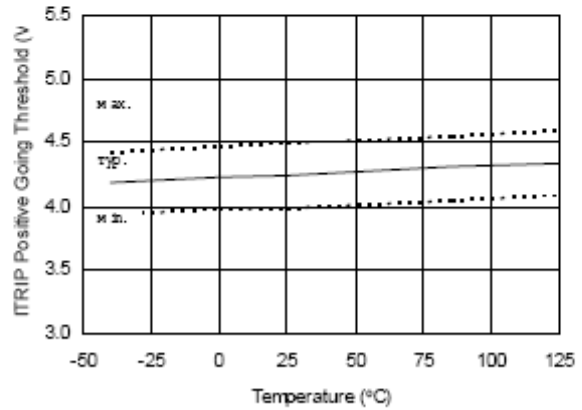
**Figure 16B. Logic "1" Input Threshold vs. Supply Voltage**



**Figure 17A. ITRIP Positive Going Threshold vs. Temperature (IR2136/21362/21363/IR21366 Only)**



**Figure 17B. ITRIP Positive Going Threshold vs. Supply Voltage (IR2136/21362/21363/IR21366 Only)**



**Figure 17C. ITRIP Positive Going Threshold vs. Temperature (IR21365/IR21367/IR21368 Only)**

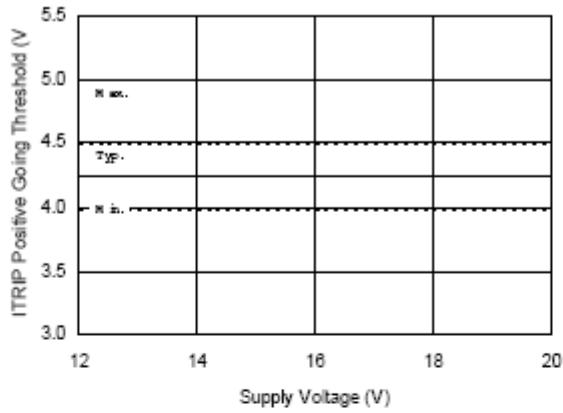


Figure 17D. ITRIP Positive Going Threshold vs. Supply Voltage (IR21365/IR21367/IR21368 Only)

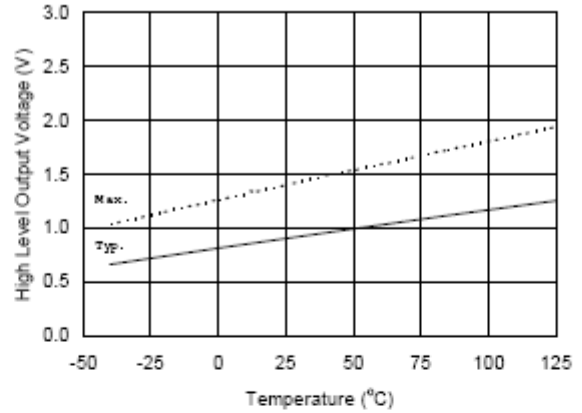


Figure 18A. High Level Output vs. Temperature

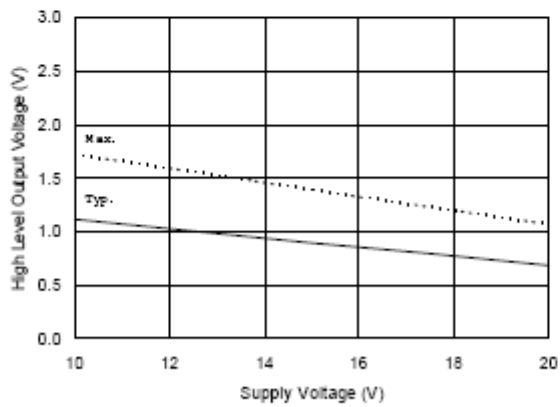


Figure 18B. High Level Output vs. Supply Voltage

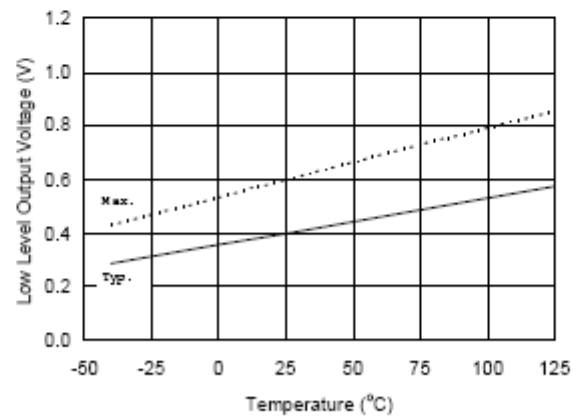


Figure 19A. Low Level Output vs. Temperature

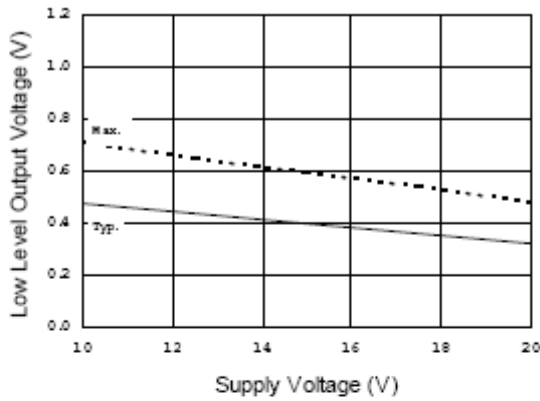


Figure 19B. Low Level Output vs. Supply Voltage



Figure 20.  $V_{CC}$  or  $V_{SS}$  Undervoltage Lockout (+) vs. Temperature (IR2136/IR21368 Only)

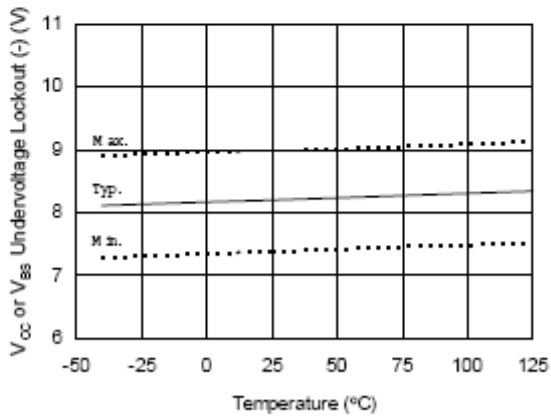


Figure 21.  $V_{CC}$  or  $V_{SS}$  Undervoltage Lockout (-) vs. Temperature (IR2136/IR21368 Only)

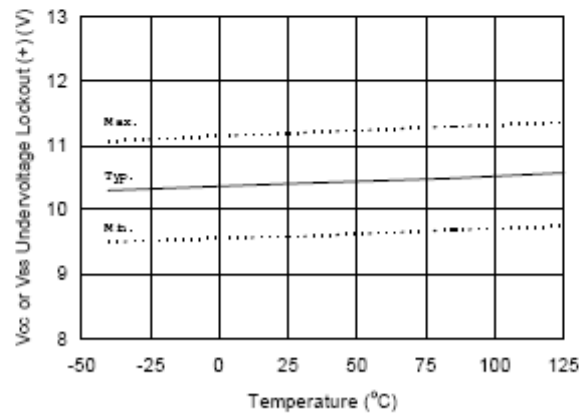


Figure 22.  $V_{CC}$  or  $V_{SS}$  Undervoltage Lockout (+) vs. Temperature (IR21362 Only)

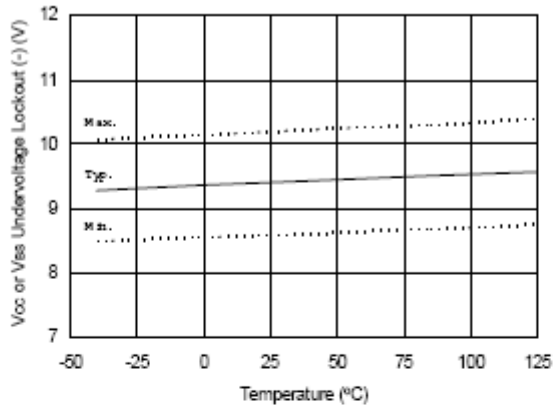


Figure 23.  $V_{CC}$  or  $V_{BS}$  Undervoltage Lockout (-) vs. Temperature (IR21362 Only)



Figure 24.  $V_{CC}$  or  $V_{BS}$  Undervoltage Lockout (+) vs. Temperature (IR21363/21365/IR21366/IR21367 Only)

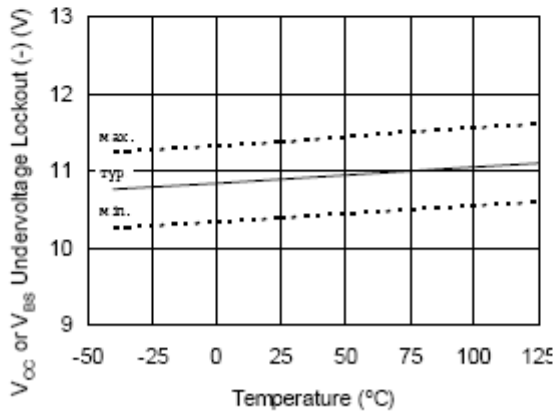


Figure 25.  $V_{CC}$  or  $V_{BS}$  Undervoltage Lockout (-) vs. Temperature (IR21363/21365/IR21366/IR21367 Only)

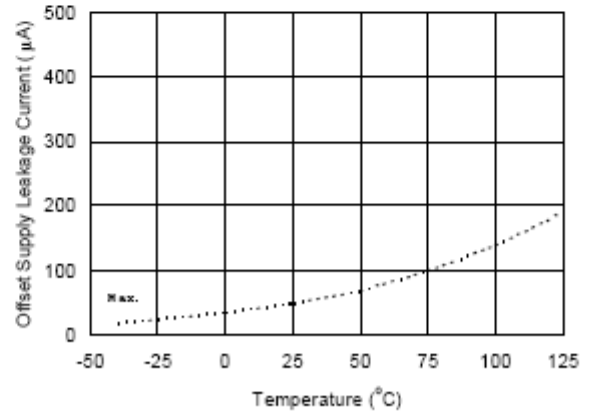


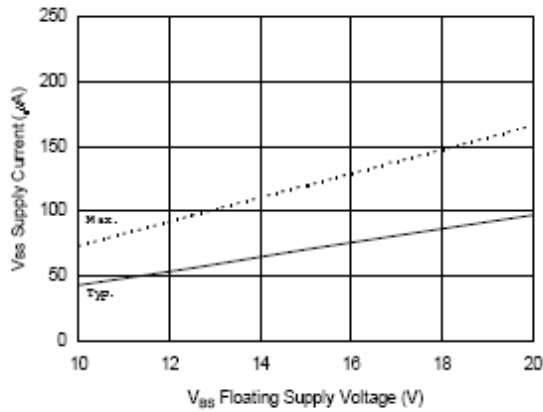
Figure 26A. Offset Supply Leakage Current vs. Temperature



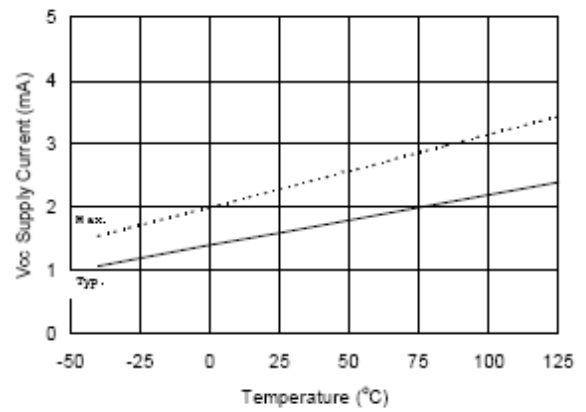
**Figure 26B. Offset Supply Leakage Current vs.  $V_B$  Boost Voltage**



**Figure 27A.  $V_{BS}$  Supply Current vs. Temperature**



**Figure 27B.  $V_{BS}$  Supply Current vs.  $V_{BS}$  Floating Supply Voltage**



**Figure 28A.  $V_{OC}$  Supply Current vs. Temperature**



Figure 28B.  $V_{CC}$  Supply Current vs.  $V_{CC}$  Supply Voltage

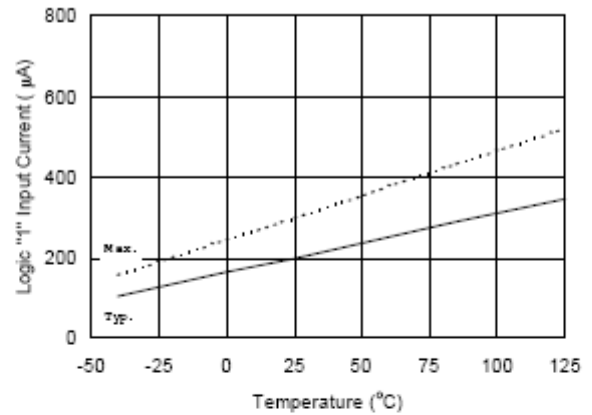


Figure 29A. Logic "1" Input Current vs. Temperature (IR2136/21363/21365 and IR21362 Low Side Only)



Figure 29B. Logic "1" Input Current vs. Supply Voltage (IR2136/21363/21365 and IR21362 Low Side Only)

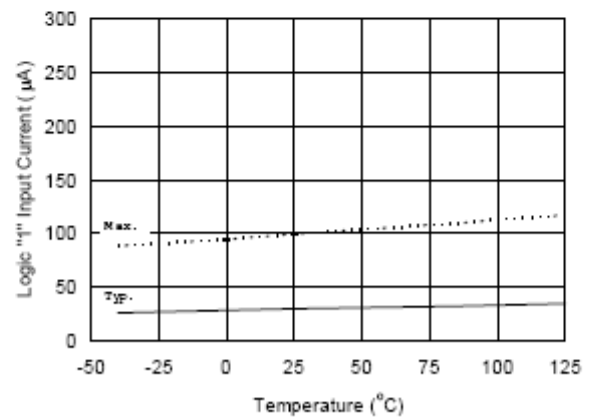


Figure 29C. Logic "1" Input Current vs. Temperature (IR21362 High Side Only)





Figure 29D. Logic "1" Input Current vs. Supply Voltage (IR21362 High Side Only)

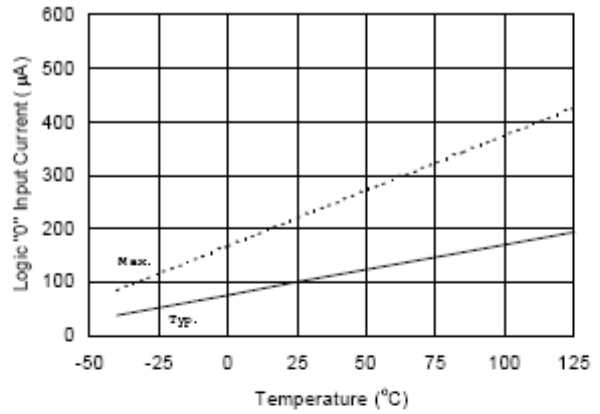


Figure 30A. Logic "0" Input Current vs. Temperature (IR2136/21363/21365 and IR21362 Low Side Only)

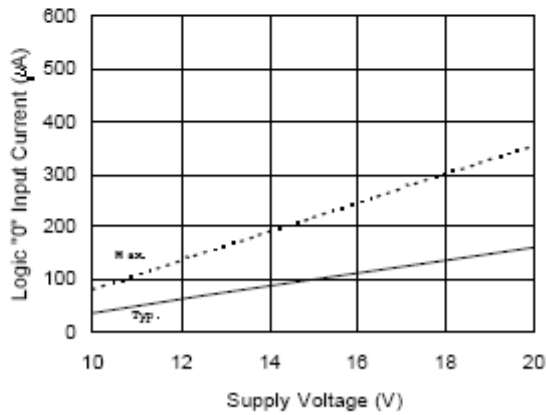


Figure 30B. Logic "0" Input Current vs. Supply Voltage (IR2136/21363/21365 and IR21362 Low Side Only)

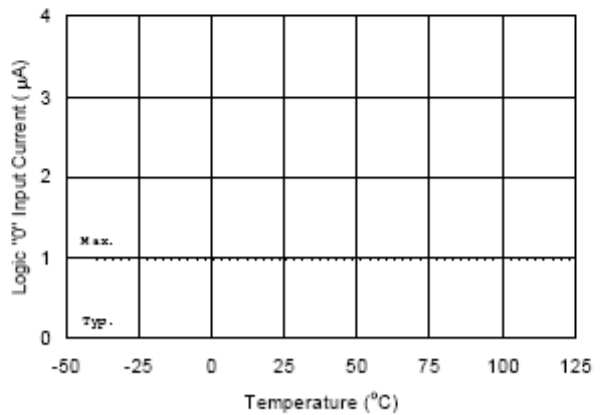


Figure 30C. Logic "0" Input Current vs. Temperature (IR21362 High Side Only)

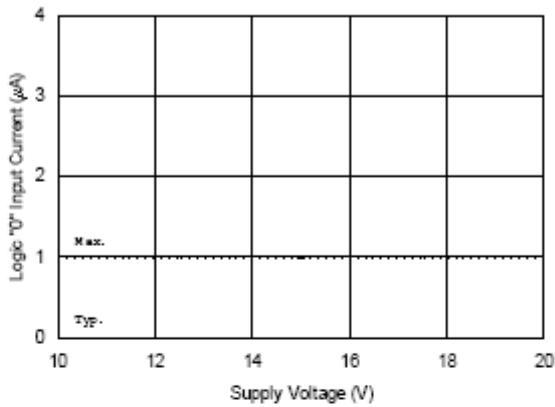


Figure 30D. Logic "0" Input Current vs. Supply Voltage (IR21362 High Side Only)



Figure 31A. "High" ITRIP Current vs. Temperature

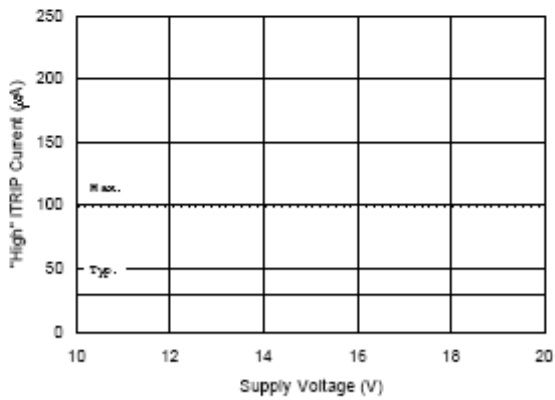


Figure 31B. "High" ITRIP Current vs. Supply Voltage

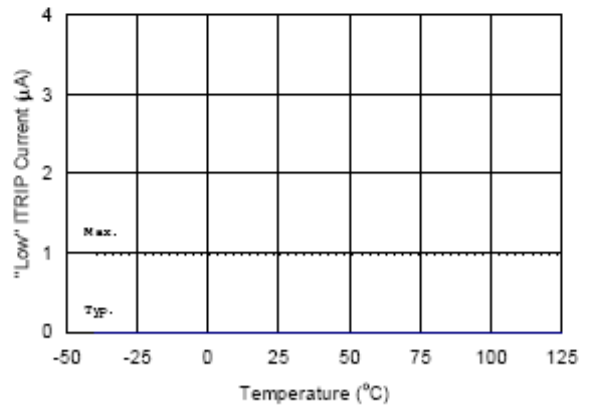


Figure 32A. "Low" ITRIP Current vs. Temperature

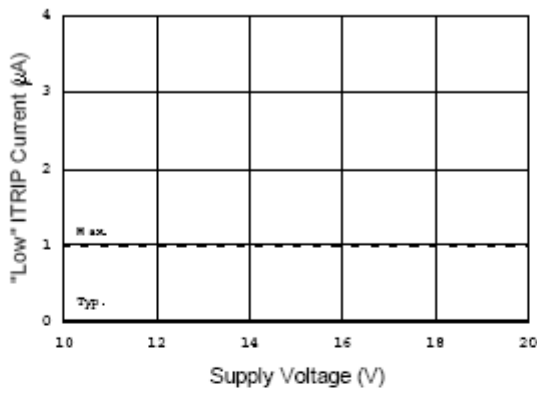


Figure 32B. "Low" ITRIP Current vs. Supply Voltage

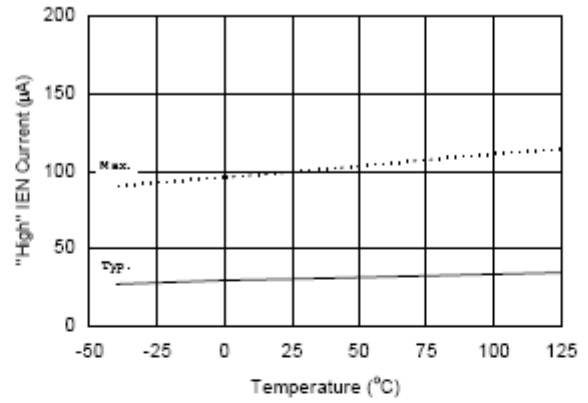


Figure 33A. "High" IEN Current vs. Temperature

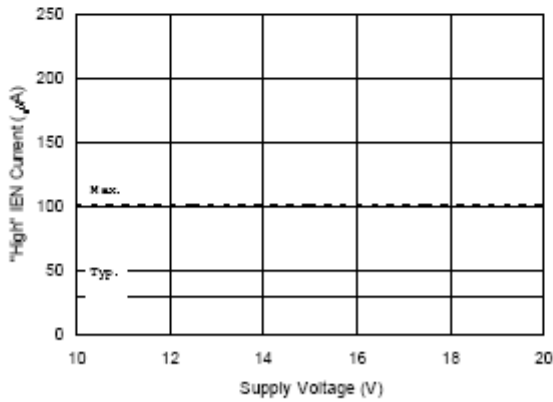


Figure 33B. "High" IEN Current vs. Supply Voltage

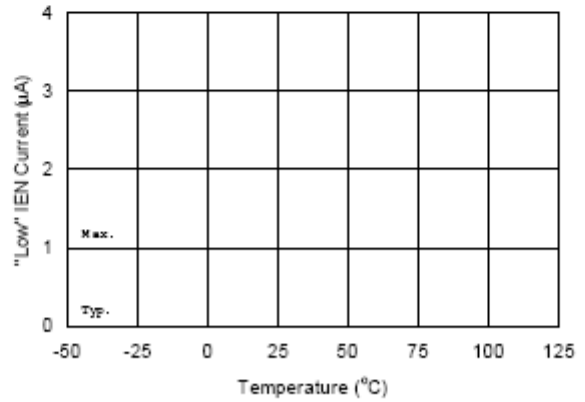


Figure 34A. "Low" IEN Current vs. Temperature

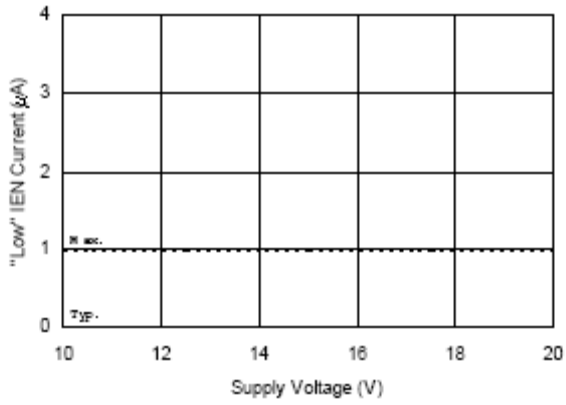


Figure 34B. "Low" IEN Current vs. Supply Voltage

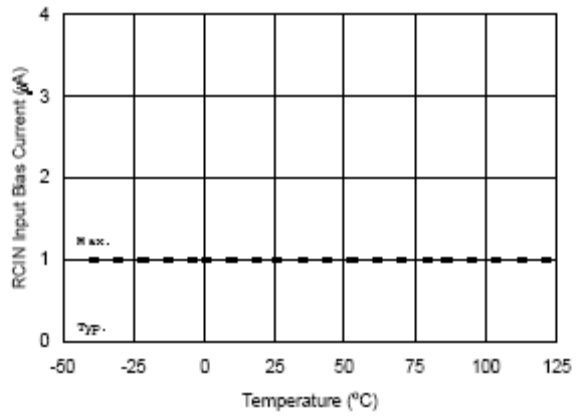


Figure 35A. RCIN Input Bias Current vs. Temperature

Figure 34B. "Low" IEN Current vs. Supply Voltage

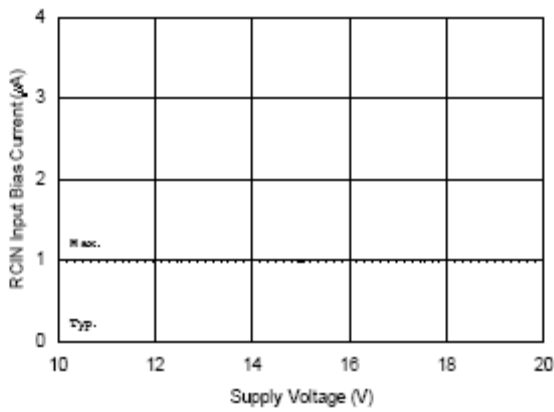


Figure 35B. RCIN Input Bias Current vs. Supply Voltage

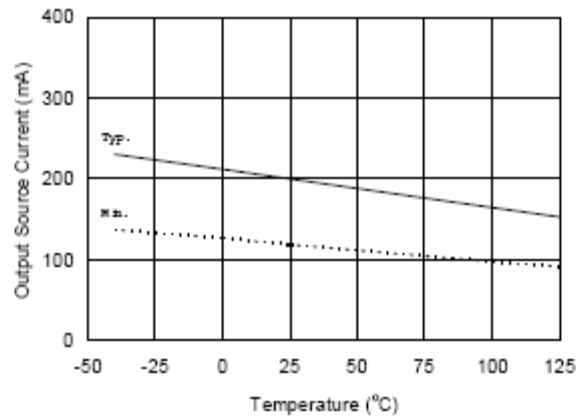
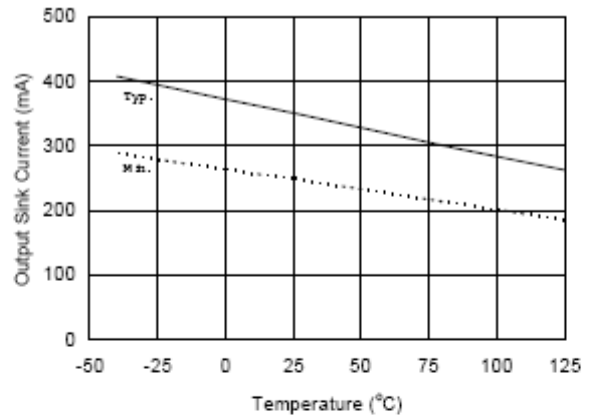


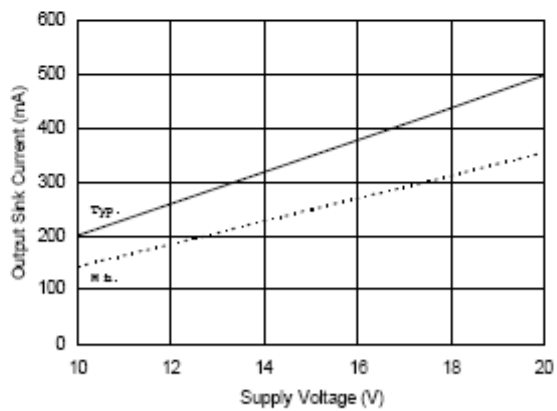
Figure 36A. Output Source Current vs. Temperature



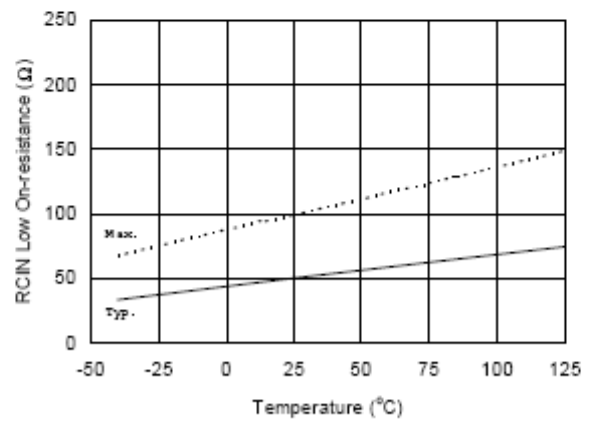
**Figure 36B. Output Source Current vs. Supply Voltage**



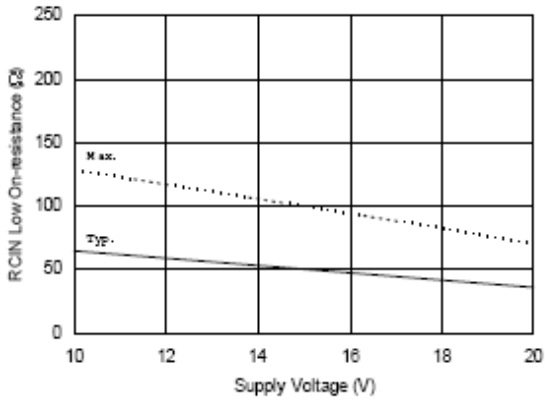
**Figure 37A. Output Sink Current vs. Temperature**



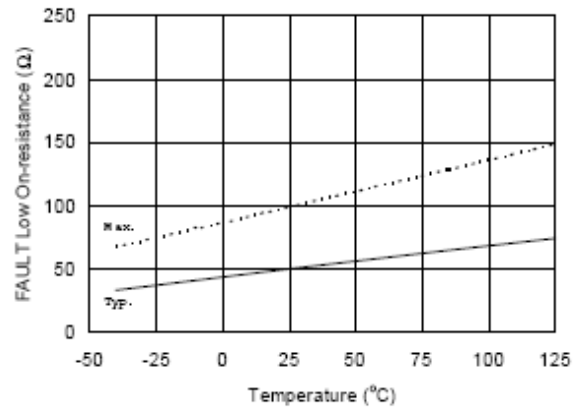
**Figure 37B. Output Sink Current vs. Supply Voltage**



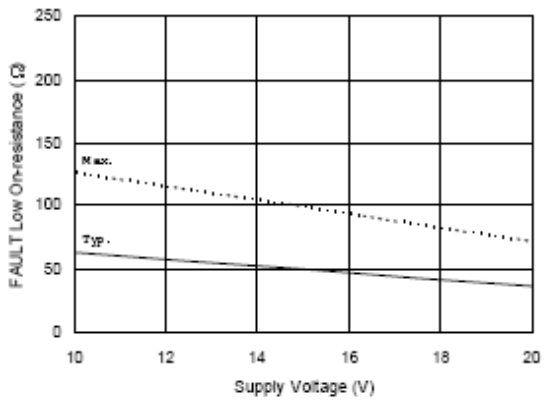
**Figure 38A. RCIN Low On-resistance vs. Temperature**



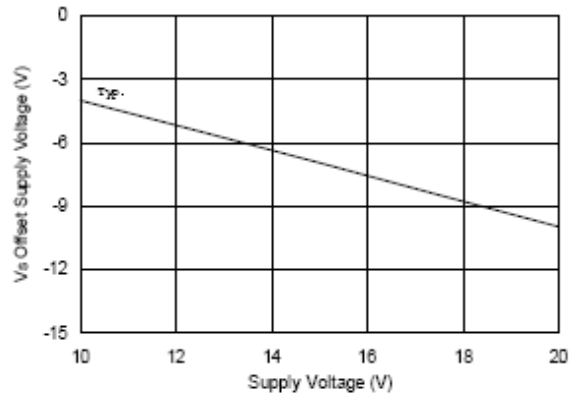
**Figure 38B. RCIN Low On-resistance vs. Supply Voltage**



**Figure 39A. FAULT Low On-resistance vs. Temperature**



**Figure 39B. FAULT Low On-resistance vs. Supply Voltage**



**Figure 40. Maximum Vs Negative Offset vs. VDS**



**Figure 41. IR2136/IR21362(3)(5)(6)(7)(8)  
 vs. Frequency (IRG4BC20W), Rgate=33Ω, Vcc=15V**



**Figure 42. IR2136/IR21362(3)(5)(6)(7)(8)  
 vs. Frequency (IRG4BC30W), Rgate=15Ω, Vcc=15V**



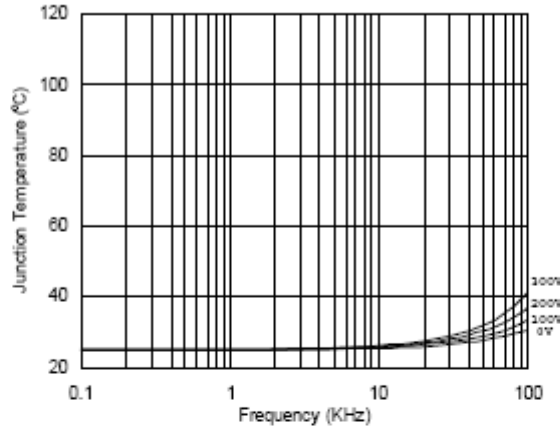
**Figure 43. IR2136/IR21362(3)(5)(6)(7)(8)  
 vs. Frequency (IRG4BC40W), Rgate=10Ω, Vcc=15V**



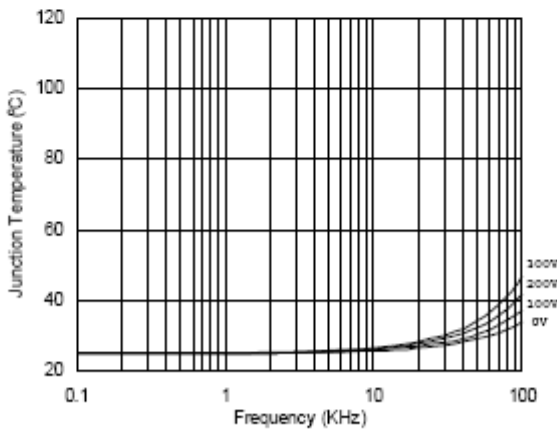
**Figure 44. IR2136/IR21362(3)(5)(6)(7)(8)  
 vs. Frequency (IRG4PC50W), Rgate=5Ω, Vcc=15V**



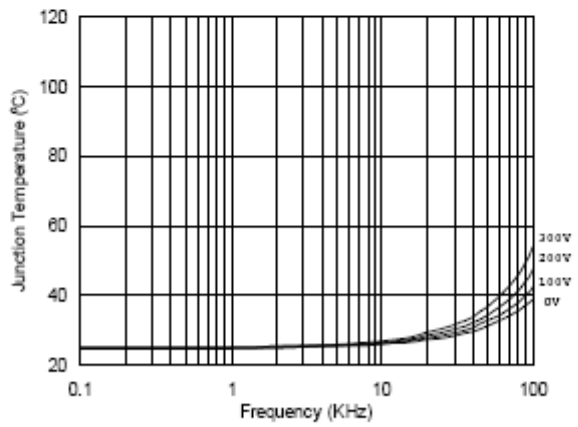
**Figure 45. IR2136/IR21362(3)(5)(6)(7)(8) (J) vs. Frequency (IRG4BC20W), Rgate=33Ω, Vcc=15V**



**Figure 46. IR2136/IR21362(3)(5)(6)(7)(8) (J) vs. Frequency (IRG4BC30W), Rgate=15Ω, Vcc=15V**

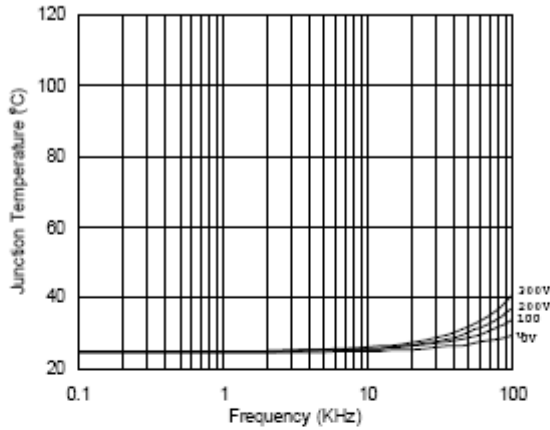


**Figure 47. IR2136/IR21362(3)(5)(6)(7)(8) (J) vs. Frequency (IRG4BC40W), Rgate=10Ω, Vcc=15V**

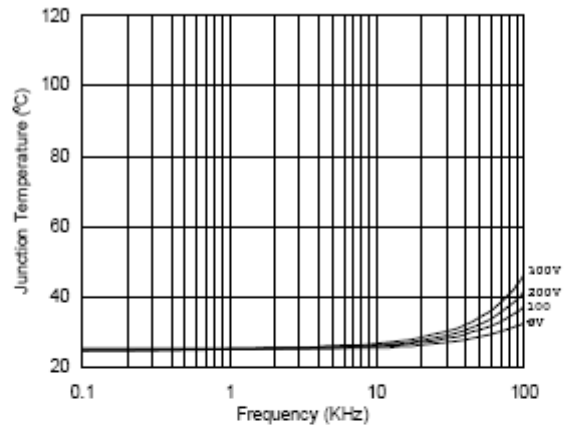


**Figure 48. IR2136/IR21362(3)(5)(6)(7)(8) (J) vs. Frequency (IRG4PC50W), Rgate=5Ω, Vcc=15V**

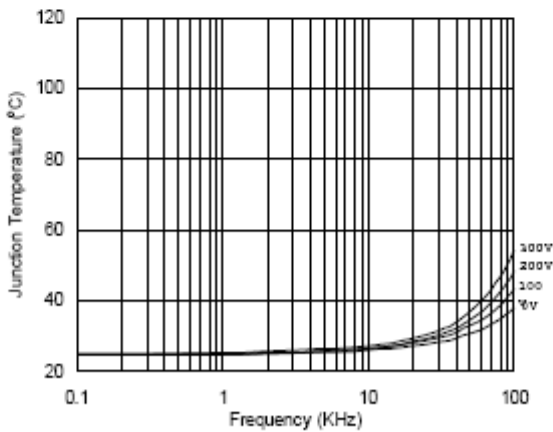




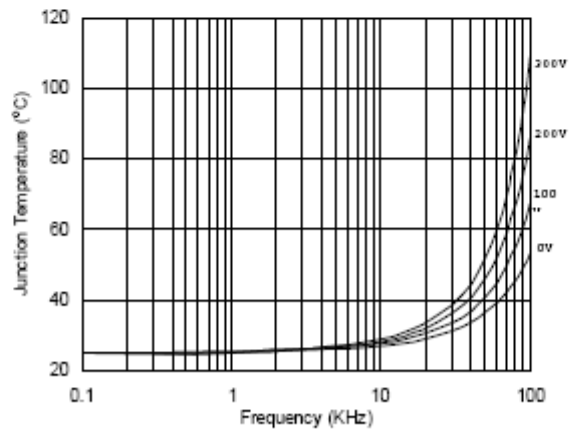
**Figure 49. IR2136/IR21362(3)(5)(6)(7)(8) (S) vs. Frequency (IRG4BC20W), R<sub>gate</sub>=33Ω, V<sub>cc</sub>=15V**



**Figure 50. IR2136/IR21362(3)(5)(6)(7)(8) (S) vs. Frequency (IRG4BC30W), R<sub>gate</sub>=15Ω, V<sub>cc</sub>=15V**

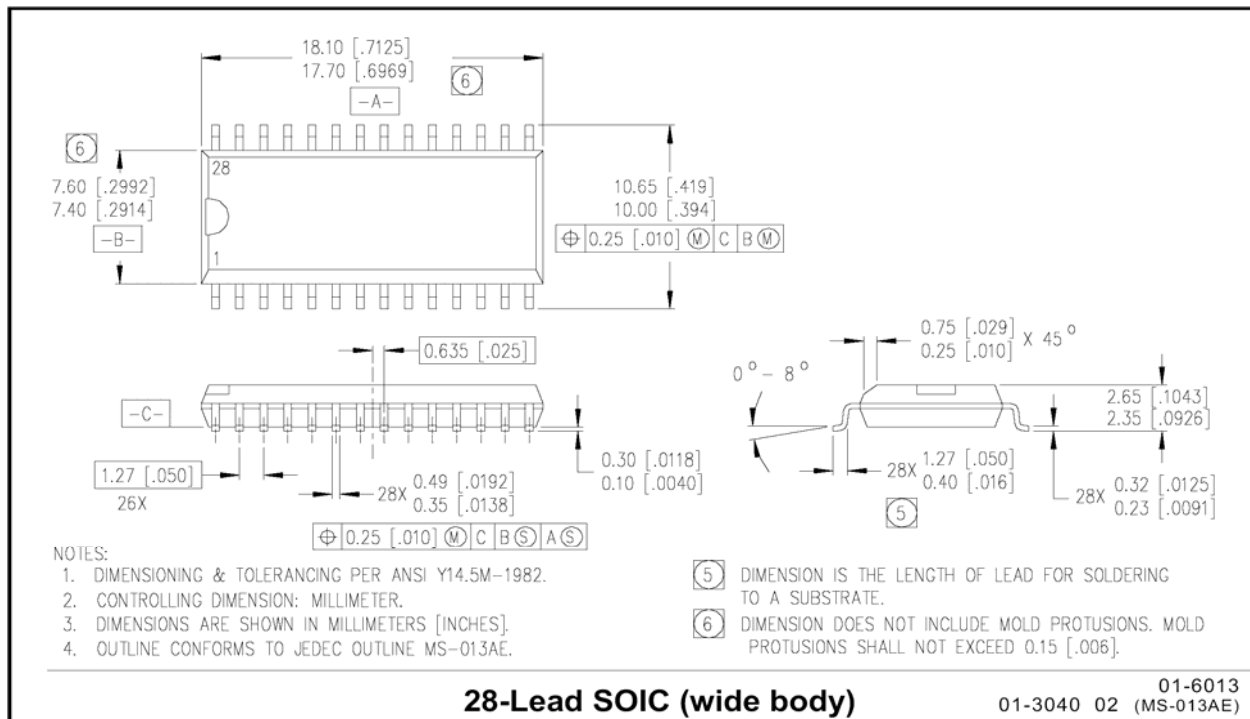
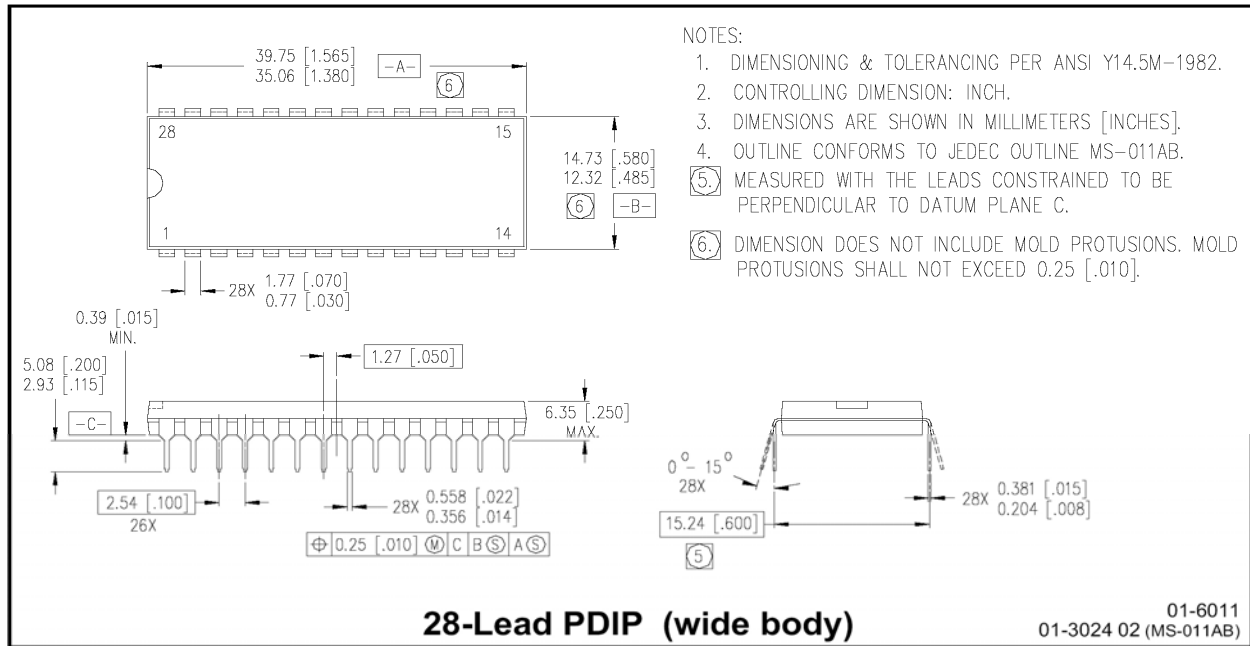


**Figure 51. IR2136/IR21362(3)(5)(6)(7)(8) (S) vs. Frequency (IRG4BC40W), R<sub>gate</sub>=10Ω, V<sub>cc</sub>=15V**

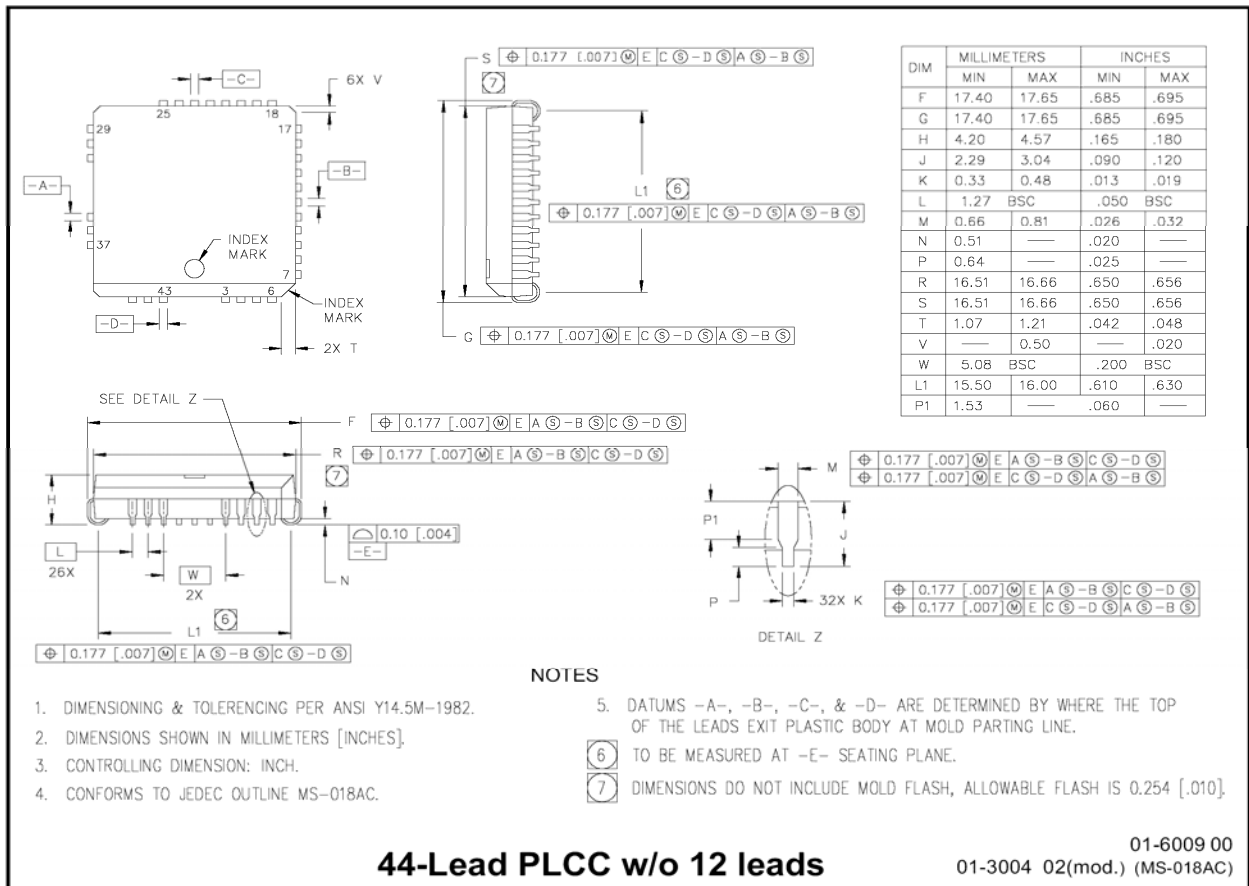


**Figure 52. IR2136/IR21362(3)(5)(6)(7)(8) (S) vs. Frequency (IRG4PC50W), R<sub>gate</sub>=5Ω, V<sub>cc</sub>=15V**

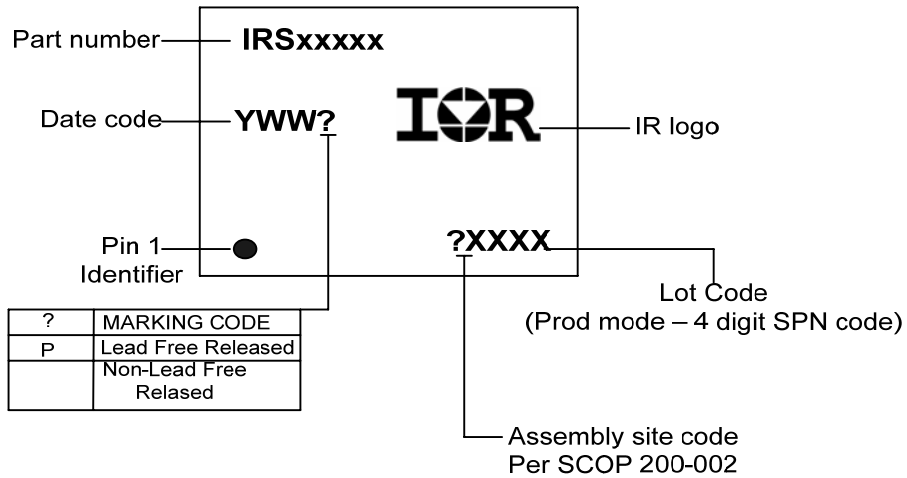
**Case Outlines**



Case Outlines



## LEAD-FREE PART MARKING INFORMATION



## ORDER INFORMATION

### Basic Part

28-Lead PDIP IR2136(3,5,6,7,8)  
 28-Lead SOIC IR2136(3,5,6,7,8)S  
 44-Lead PLCC IR2136(3,5,6,7,8)J  
 28-Lead PDIP IR21362  
 28-Lead SOIC IR21362S  
 44-Lead PLCC IR21362J

Order IR2136(3,5,6,7,8)  
 Order IR2136(3,5,6,7,8)S  
 Order IR2136(3,5,6,7,8)J  
 Order IR21362  
 Order IR21362S  
 Order IR21362J

### Lead-Free Part

28-Lead PDIP IR2136(3,5,6,7,8)  
 28-Lead SOIC IR2136(3,5,6,7,8)S  
 44-Lead PLCC IR2136(3,5,6,7,8)J  
 28-Lead PDIP IR21362  
 28-Lead SOIC IR21362S  
 44-Lead PLCC IR21362J

Order IR2136(3,5,6,7,8)PbF  
 Order IR2136(3,5,6,7,8)(S)PbF  
 Order IR2136(3,5,6,7,8)(J)PbF  
 Order IR21362PbF  
 Order IR21362SPbF  
 Order IR21362JPbF